



# ***PRICELIST 2024***

With the appearance of this price list all previous price lists of WIFO expire. All prices are in euros and are not binding. Moreover, all prices exclude VAT. All prices and manuals of our products can be found on [www.wifo.nl](http://www.wifo.nl). Price and construction changes reserved. All sizes, weights, capacities, etc. quoted are approximate.

All our quotations, all orders placed with us and all contracts concluded with us, are subject to the METAALUNIE CONDITIONS. These conditions are filed with the register of the District Court of Rotterdam.

Upon delivery of a WIFO product to the end user, the seller ensures the machine is safe and delivered with the user manual and safety regulations included.

#### Delivery

■ For deliveries within the Netherlands under € 800, - excl. VAT, transportation costs will be charged. Deliveries over € 750, - excl. VAT are free of transportation costs.

■ For deliveries outside the Netherlands, the transport costs will be fully charged.  
Complaints within 8 days.

#### Returns

Returns are only allowed after approval by WIFO-Anema Bv. Returns will not be credited when articles are used, assembled, painted or damaged and not saleable by WIFO. Returns should always be free of charge. An unaccepted return by WIFO will not release a customer from its commitments.

#### Finishing

WIFO products are supplied as standard in red top coat (RAL 3002). Anthracite (RAL 7021) is applied on request.

KvK: 01055959

BTW nr.: NL008716390B01



Hegebeintumerdyk 37  
9172 GP Ferwert  
The Netherlands



+31 (0)518 411318



[info@wifo.nl](mailto:info@wifo.nl)



[@wifoanema](https://www.facebook.com/wifoanema)



[@wifoanema](https://twitter.com/wifoanema)

**BOX ROTATORS**

- 10 Box rotator
- 11 Box rotator with side-shift
- 12 Box rotator with Fork positioner
- 13 Rotator 360°
- 14 Attachment to box rotator
- 16 Forward tipping box rotator for telehandlers
- 17 Forward tipping box rotator 135°
- 18 Forward tipping box rotator 180°
- 19 Forward tipping box rotator 180° (heavy duty)
- 20 Forward tipping box rotator 150°
- 21 Attachment to forward tipping box rotator
- 22 Stationary box rotator

**BUCKETS**

- 26 Loading bucket (fork mounted)
- 27 Loading bucket (fork carriage mounted)
- 28 Loading bucket (heavy duty, fork mounted)
- 29 Loading bucket (heavy duty, model fork carriage mounted)
- 30 Loading bucket for reach loaders
- 32 Bulk loading bucket (fork mounted)
- 33 Bulk loading bucket (fork carriage mounted)
- 34 Bulk loading bucket (heavy duty, fork mounted)
- 35 Bulk loading bucket (heavy duty, fork carriage mounted)
- 36 Mechanical bucket (fork mounted)
- 37 Hydraulic bucket (fork mounted)
- 38 Tipping container (fork mounted)
- 39 Loading bucket
- 40 Hydraulic grapple bucket

**SIDESHIFTS | FORK POSITIONER**

- 42 Three-point linkage side-shift (PTO)
- 43 Three-point linkage side-shift (heavy duty)
- 44 Smart camera side-shift (three-point linkage, heavy duty)
- 46 Side-shift for forklift and telehandler
- 47 Fork positioner

**BALE CLAMPS AND BALE SPEAR**

- 50 Bale clamp for rectangular bales
- 51 Bale clamp for round bales
- 52 Bale spear

**LIFTING MASTS AND PALLET CARRIERS**

- 54 Lifting mast
- 55 Lifting mast (see-through model)
- 56 Lifting mast see-through model (heavy duty)
- 57 Accessories for lifting masts
- 58 Pallet carrier with fixed forks
- 59 Pallet carrier with adjustable forks

**TILLAGE EQUIPMENT**

- 62 Cultivator (working depth 500 mm)
- 63 Subsoiler (working depth 400 mm)
- 64 Subsoiler (working depth 500 mm)
- 65 Subsoiler (working depth 700 mm)
- 66 Subsoiler (working depth 700 mm)

**SCRAPERS**

- 68 Rubber scraper
- 69 Rubber scraper (fork mounted)
- 70 Rubber scraper for telehandler/shovel

**TOOL CARRIERS**

- 72 Tool carrier for 3-point hitch equipment
- 74 Tool carrier for 3-point hitch equipment (heavy duty)

**DRAINAGE MACHINE**

- 76 Drainage machine

**OTHER PRODUCTS**

- 80 Forklift forks
- 81 Tilting frame
- 82 Adaptors
- 85 Attachments
- 86 Measurement overview of attachments

**LEGENDA**

Forklift



Tractor



Telehandler



Shovel





**MORE INFO?**  
Scan the QR code

**WWW.WIFO.NL/EN**  
For more information and specifications  
of our products



**LOOKING FOR SPECIFIC PARTS?**  
We like to help you!



+31 (0)518 745038

spareparts@wifo.nl

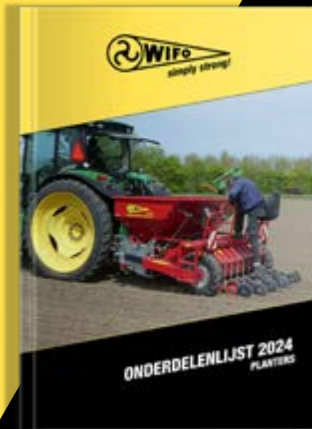

+31 (0)518 411318

IN THE SPOTLIGHT!



 **VIDEO**  
Scan the QR-code

**SMART CAMERA SIDESHIFT**



 **VIDEO**  
Scan the QR-code

**TOOL CARRIER**

IN THE SPOTLIGHT!

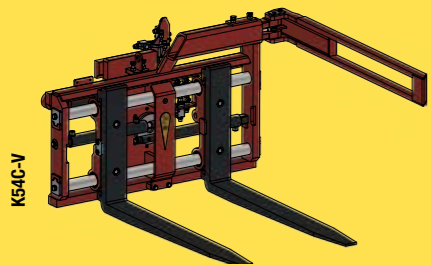
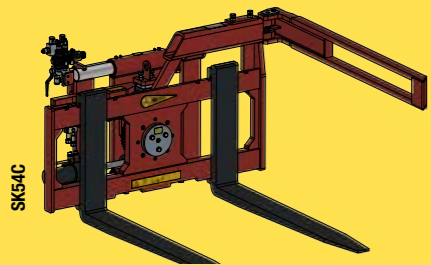
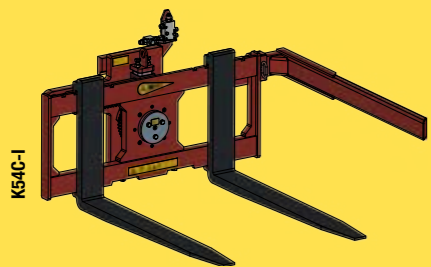

## SPECIALIST IN BOX ROTATORS

- ✓ Efficient and dosed discharging of boxes
- ✓ Product- and boxfriendly handling
- ✓ Suitable for any type of box
- ✓ Suitable for forklift, telehandler, shovel, etc.



## BOX ROTATOR



K54C-I

- Maximum box width: 1800 mm
- 180° rotation angle (left rotation as standard)
- Open construction for optimal visibility on the forklift forks
- Plug-in or folding third fork with gas spring
- Third fork in width adjustable
- High quality tipping shaft with sleeve bearing
- Including hoses and quick connectors
- Excluding forklift forks
- Equipped with durable and replaceable sprocket and gear rack (width 50 mm)



K54C-0

Type	Maximum load	Height of the fork carrier	Frontal extension length	Center of Gravity	Height third fork*	Fork carrier width	Weight	Price
K54A-I (plugin)	2.500 kg	FEM2: 407 mm	165 mm	133 mm	360 mm	1.000 mm	240 kg	€ 3.350,-
K54A-0 (foldaway)	2.500 kg	FEM2: 407 mm	165 mm	158 mm	660 mm	1.000 mm	270 kg	€ 3.700,-
K54C-I (plugin)	3.500 kg	FEM3: 508 mm	185 mm	134 mm	460 mm	1.200 mm	315 kg	€ 3.975,-
K54C-0 (foldaway)	3.500 kg	FEM3: 508 mm	185 mm	158 mm	760 mm	1.200 mm	345 kg	€ 4.325,-

\* Calculated from the top of the fork to the bottom of the fork carrier

### Options

- Rotation angle up to 200° I/O 180° € 200,-
- Right rotated instead of left rotated € 250,-
- Topfork (detachable) € 450,-
- Hydraulic connection on fork carrier (rotating, not in combination with 200° rotation angle) € 325,-
- Hydraulic connection (not rotating) € 225,-
- Rapid coupling € 325,-
- Adjustable ball bearing instead of sleeve bearing € 950,-
- Attachment to frontloader or telehandler See page 14

Rapid coupling



## BOX ROTATOR WITH SIDE-SHIFT



SK54C

- Maximum box width: 1800 mm
- 180° rotation angle (left rotation as standard)
- Open construction for optimal visibility on the forklift forks
- Folding third fork using gas spring
- Third fork in width adjustable
- High quality tipping shaft with sleeve bearing
- Integrated side-shift (200 mm)
- Including hoses and quick connectors
- Four-hose connections as standard
- Excluding forklift forks
- Equipped with durable and replaceable sprocket and gear rack (width 50 mm)



SK54A

Type	Maximum load	Height of the fork carrier	Frontal extension length	Center of Gravity	Height third fork*	Fork carrier width	Weight	Price
SK54A	2.500 kg	FEM2: 407 mm	173 mm	141 mm	660 mm	1.000 mm	335 kg	€ 5.475,-
SK54C	3.500 kg	FEM3: 508 mm	188 mm	145 mm	760 mm	1.200 mm	405 kg	€ 6.075,-

\* Calculated from the top of the fork to the bottom of the fork carrier

### Options

- Electrical hydraulic switching valve € 350,-
- Rotation angle up to 200° I/O 180° € 200,-
- Right rotated instead of left rotated € 250,-
- Topfork (detachable) € 450,-
- Hydraulic connection (not turning) € 225,-
- Rapid coupling € 325,-
- Adjustable ball bearing instead of sleeve bearing € 950,-
- Attachment to frontloader or telehandler See page 14

SK54C



## BOX ROTATOR WITH FORK POSITIONER



K54C-V



K54C-V

- Maximum box width: 1800 mm
- 180° rotation angle (left rotation as standard)
- Fork guides have bearings over hard-chromed shafts
- Adjustment range 280-980 mm centres
- Open construction for optimal visibility on the forklift forks
- Folding third fork with gas spring
- Third fork in width adjustable
- High quality tipping shaft with sleeve bearing
- Four-hose connections as standard
- Including hoses and quick connectors
- Including bolted forklift forks FEM3A (125x45x1200 mm)
- Equipped with durable and replaceable sprocket and gear rack (width 50 mm)

Type	Maximum load	Height of the fork carrier	Frontal extension length	Center of Gravity	Height third fork*	Weight	Price
K54C-V	3.500 kg	FEM3: 508 mm	326 mm	290 mm	760 mm	655 kg	€ 8.550,-

\* Calculated from the top of the fork to the bottom of the fork carrier

### Options

- Electrical hydraulic switching valve € 350,-
- Integrated sideshift (beware, six-hose connection) € 550,-
- Right rotated instead of left rotated € 250,-
- Rapid coupling € 325,-
- Adjustable ball bearing instead of sleeve bearing € 950,-
- Attachment to frontloader or telehandler See page 14

## ROTATOR 360°



KRM360C



KRM360C



KRM360C

- Maximum box width: 1800 mm
- 360° rotation angle (both left and right)
- Suitable for heavy duty circumstances
- Open construction for optimal visibility on the forklift forks
- Heavy duty folding third fork, using gas spring
- Adjustable third fork, applicable on left and right side
- High quality closed slewing ring with hydraulic motordrive
- Complete with hoses and quick connectors
- Horizontal indicator
- Excluding forklift forks

Type	Maximum load	Height of the fork carrier	Frontal extension length	Center of Gravity	Height third fork*	Fork carrier width	Weight	Price
KRM360A	2.500 kg	FEM2: 407 mm	145 mm	85 mm	700 mm	1.200 mm	425 kg	€ 9.650,-
KRM360C	3.800 kg	FEM3: 508 mm	155 mm	90 mm	800 mm	1.200 mm	530 kg	€ 10.650,-

\* Calculated from the top of the fork to the bottom of the fork carrier

**i** On request we adjust the rotator for boxes wider than 1800 mm. Ask for the possibilities!

### Options

- Hydraulic connection on fork carrier, 1 x DA € 1.050,-
- Hydraulic connection on fork carrier, 2 x DA € 1.300,-
- Rapid coupling € 500,-
- Attachment to frontloader or telehandler See page 14



## ATTACHMENT BOX ROTATOR

To use a WIFO box rotator in combination with your frontloader or telehandler you need an adapter.

The adapter consists of a fork carriage with attachment parts. The box rotator will be mounted on the adapter.

Follow the next steps for the correct configuration of the adapter:

- 1 Choose the fork carriage (page 59)**  
Check the height of the fork carriage (FEM size) of the rotator



- 2 Choose attachment parts (page 85)**  
Choose the attachment parts that belong to the telehandler or front loader

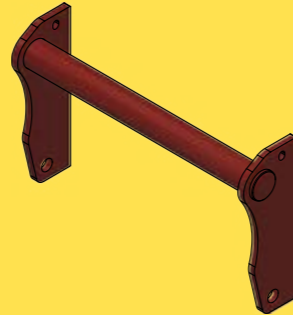

- 3 Choose forklift forks (optional) (page 85)**  
Optionally, you can choose for a set of forklift forks

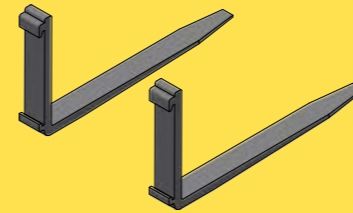

- ✓ Box rotator + adaptor**

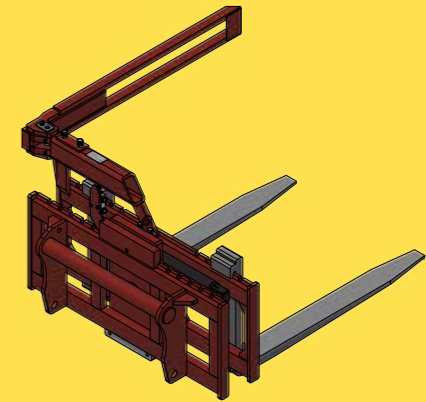

## FORWARD TIPPING BOX ROTATOR FOR TELEHANDLERS



K75B Maniscope



- 110° tipping angle + vehicle tilt angle
- Only suitable for telehandler
- Clamps exactly on the box edge (for 1600 and 1800 mm wide boxes)
- Suitable for all marks of telehandlers
- No rotation elements next to the box
- Suitable for boxes with or without bottom deck
- Box depth adjustable between 850 - 1250 mm
- Box height adjustable between 800 - 1250 mm
- Complete with hydraulic hoses and quick connectors
- Standard equipped with sequence valve (2 hose connection)



▶ Video

K75B Maniscope



### K75A:

- Suitable for box widths between 1200 - 1800 mm
- Two fixed forks as standard (790 mm centers)
- 1 clamping cylinder

### K75B:

- Suitable for box widths > 1800 mm
- With FEM2 fork carriage (1460 mm) and two adjustable forks instead of welded forks
- 2 clamping cylinders

Type	Maximum load	Frontal extension length	Center of Gravity	Weight	Price
K75A	1.750 kg	500 mm	500 mm	615 kg	€ 8.250,-
K75B	2.750 kg	570 mm	531 mm	840 kg	€ 11.000,-

### Options

- Roll-over upper clamp for boxes > 1200 mm
- With four instead of two forks (for box width 2400 mm)
- Attachment parts for telehandler

€ 525,-

€ 2000,-

See page 85

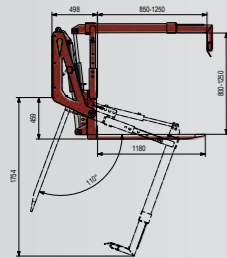

## FORWARD TIPPING BOX ROTATOR 135°



K80-1600



- 135° tipping angle
- Suitable for boxes with or without bottom deck
- Clamps exactly on the box edge
- Box depth adjustable between 850 - 1200 mm
- Box height adjustable between 850 - 1250 mm
- With rapid connection system suitable for FEM2 and FEM3
- Standard with 2 fixed forks
- Complete with hoses and quick connectors
- Standard equipped with sequence valve (2 hose connection)



▶ Video

K80-1600



Type	Maximum load	Maximum rotation capacity	Frontal extension length	Center of Gravity	Maximum box width	Fork distance (center to center)	Weight	Price
K80-1200	2.500 kg	1.750 kg	440 mm	560 mm	1.200 mm	700 mm	580 kg	€ 8.125,-
K80-1400	2.500 kg	1.750 kg	440 mm	560 mm	1.400 mm	700 mm	610 kg	€ 8.225,-
K80-1600	2.500 kg	1.750 kg	440 mm	560 mm	1.600 mm	800 mm	640 kg	€ 8.325,-
K80-1800	2.500 kg	1.750 kg	440 mm	560 mm	1.800 mm	800 mm	670 kg	€ 8.425,-
K80-2000	2.500 kg	1.750 kg	440 mm	560 mm	2.000 mm	1.000 mm	700 kg	€ 8.525,-

### Options

- Attachment parts for frontloader/telehandler

See page 21

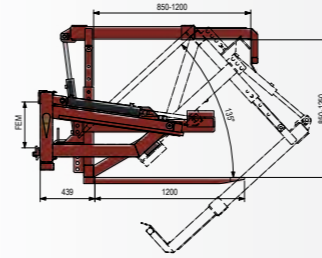

## FORWARD TIPPING BOX ROTATOR 180°



K85-1600

- 180° tipping angle
- Suitable for boxes with or without bottom deck
- Clamps exactly on the box edge
- Box depth adjustable between 850 - 1200 mm
- Box height adjustable between 850 - 1250 mm
- Rapid connection system FEM2 and FEM3
- Standard with two fixed forks
- Complete with hydraulic hoses and quick connectors
- Standard equipped with sequence valve (2 hose connection)



K85-1600

Type	Maximum load	Maximum rotation capacity	Frontal extension length	Center of gravity	Maximum box width	Fork distance (center to center)	Weight	Price
K85-1200	2.500 kg	1.750 kg	440 mm	625 mm	1.200 mm	700 mm	700 kg	€ 10.200,-
K85-1400	2.500 kg	1.750 kg	440 mm	625 mm	1.400 mm	700 mm	725 kg	€ 10.300,-
K85-1600	2.500 kg	1.750 kg	440 mm	625 mm	1.600 mm	800 mm	745 kg	€ 10.400,-
K85-1800	2.500 kg	1.750 kg	440 mm	625 mm	1.800 mm	800 mm	765 kg	€ 10.500,-
K85-2000	2.500 kg	1.750 kg	440 mm	625 mm	2.000 mm	1.000 mm	790 kg	€ 10.600,-

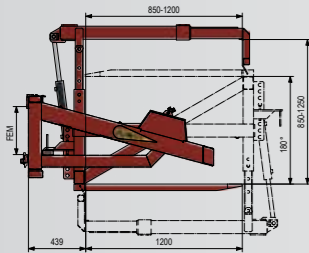

### Options

- Attachment parts for frontloader/telehandler

See page 21

## FORWARD TIPPING BOX ROTATOR 180° (HEAVY DUTY MODEL)



K90-1600

- 180° tipping angle
- Standard equipped with roll-over clamp
- Suitable for boxes with or without bottom deck
- For box height between 800 - 1250 mm
- Rapid connection system FEM2 and FEM3 (K90-2400: FEM3 and FEM4)
- 2 adjustable forks as standard (K90-2400: 4 adjustable forks)
- Complete with hydraulic hoses and quick connectors
- Standard equipped with sequence valve (2 hose connection)



K90-1600

Type	Maximum load	Maximum rotation capacity	Frontal extension length	Center of Gravity	Maximum box width	Weight	Price
K90-1600	2.750 kg	2.000 kg	460 mm	530 mm	1.600 mm	945 kg	€ 12.475,-
K90-1800	2.750 kg	2.000 kg	460 mm	530 mm	1.800 mm	970 kg	€ 12.600,-
K90-2000	2.750 kg	2.000 kg	460 mm	530 mm	2.000 mm	995 kg	€ 12.725,-
K90-2240	2.750 kg	2.000 kg	460 mm	460 mm	2.240 mm	1.020 kg	€ 12.850,-
K90-2400	2.750 kg	2.000 kg	460 mm	560 mm	2.400 mm	1.115 kg	€ 13.800,-

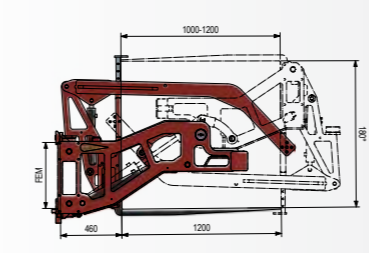

### Options

- Depth adjustment for various boxes (1000 - 1100 mm deep)
- Attachment parts for telehandler



▶ Video

€ 300,-  
See page 21

## FORWARD TIPPING BOX ROTATOR 150°



K95



K95

- Without pivots on the side of the box
- 150° tipping angle
- Suitable for boxes with or without bottom deck
- Adjustable for box depths between 1000 - 1200 mm
- Adjustable for box height between 975 - 1275 mm
- Rapid connection system FEM3
- 2 adjustable forks as standard
- Complete with hoses and quick connectors
- Standard equipped with sequence valve (2 hose connection)



▶ Video

Type	Maximum load	Maximum rotation capacity	Frontal extension length	Center of Gravity	Weight	Price
K95	2.750 kg	2.000 kg	460 mm	355 mm	975 kg	€ 17.750,-

### Options

- Rapid connection system FEM4 (I/O FEM3)
- Clamps exactly on the box edge for boxes of 1800 mm width
- Upper clamp with extendable parts for boxes width from 1800 - 2400 mm
- Equipped with an extended fork carriage and 4 adjustable forks (for 2400 mm boxes)
- Attachment for telehandler

€ 300,-

€ 150,-

€ 125,-

€ 1.100,-

See page 21

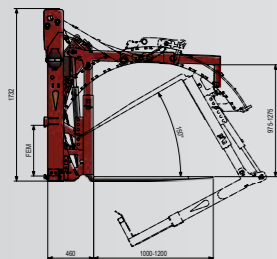

## ATTACHMENT FORWARD TIPPING BOX ROTATOR

1

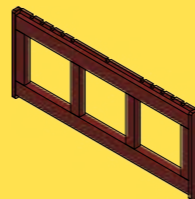

2

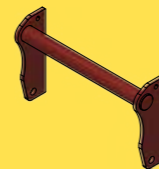

✓

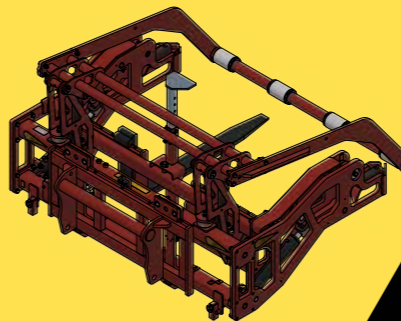

To use a WIFO forward tipping box rotator in combination with your telehandler you need an adaptor.

The adaptor consists of a fork carriage with attachment parts. The forward tipping box rotator will be mounted on the adaptor.

Follow the next steps for the correct configuration of the adaptor:

1

### Choose fork carriage (page 59)

Check the height of the fork carriage (FEM size) of the forward tipping rotator

2

### Choose attachment parts (page 85)

Choose the attachment parts that belong to the telehandler

✓

### Forward tipping box rotator + adaptor

## STATIONARY BOX ROTATOR

K60-1600



- Stationary box rotator with a maximal tipping angle of 142°
- Standard discharge height 1125 mm
- Hydraulic unit and control directly at frame (both left and right possible)
- Adjustable for box heights between 800 - 1400 mm
- Maximal box depth 1200 mm
- Adjustable discharge hopper
- Easily moved with forklift truck
- Equipped with a CEE contra plug (5 pin)

Control directly on frame



Type	Max. capacity	Total width	Weight	Price
K60-1200	2.000 kg	1.720 mm	855 kg	€ 8.550,-
K60-1400	2.000 kg	1.920 mm	875 kg	€ 8.775,-
K60-1600	2.000 kg	2.120 mm	895 kg	€ 9.000,-
K60-1800	2.000 kg	2.320 mm	915 kg	€ 9.225,-
K60-2000	2.000 kg	2.520 mm	935 kg	€ 9.450,-
K60-2240	2.000 kg	2.760 mm	1015 kg	€ 9.675,-
K60-2400	2.000 kg	2.920 mm	1060 kg	€ 9.900,-

### Options

- Different discharge height € 375,-
- Dosed discharge hopper (mechanical) € 975,-
- Dosed discharge hopper (hydraulic) € 1.525,-
- Wireless remote control (direct control) € 1.875,-
- Automatic tilt control On request

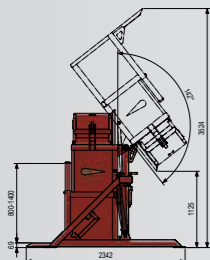

K60-1600 with automatic tilt control



## K60

**1** Automatic tilt control

**2** Maximal tipping angle of 142°

**3** Wired pendant push button station for both automatic and manual operation

**4** Walk-in protection with 2 photocells

STATIONAIRE KISTENKANTELAAR

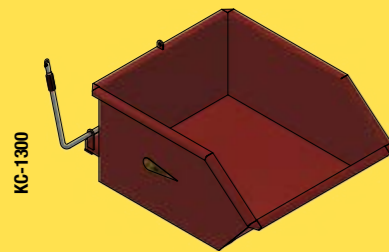

### EFFICIENT LOADING AND UNLOADING!

- ✓ Suitable for products vulnerable to damage (HOD)
- ✓ Suitable for intensive daily use
- ✓ Suitable for any type of product
- ✓ Suitable for forklift, telehandler, shovel, etc.

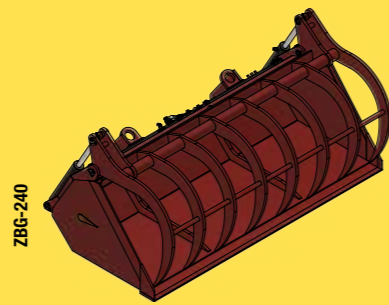

## LOADING BUCKET (FORK MOUNTED)



HOD-200 RVS

- Suitable for products vulnerable to damage
- Double hinge device for a minimum of loss in dump height
- See-through grille for optimal visibility
- 6 mm plate thickness
- Equipped with manganese wearing strip (80x15 mm)
- Fork Sleeves: 159x69-L1197 mm, c.t.c. 830 mm
- Including hydraulic hoses and quick connectors



HOD-200 RVS

Type	Breedte bak	Diepte bak	Hoogte bak	Inhoud	Center of Gravity	Gewicht	Prijs	Meerprijs RVS bodem
HOD-150	1.500 mm	1.550 mm	850 mm	1.100 l	900 mm	405 kg	€ 3.675,-	€ 525,-
HOD-175	1.750 mm	1.550 mm	850 mm	1.300 l	900 mm	440 kg	€ 3.775,-	€ 575,-
HOD-200	2.000 mm	1.550 mm	850 mm	1.500 l	900 mm	475 kg	€ 3.875,-	€ 625,-
HOD-225	2.250 mm	1.550 mm	850 mm	1.700 l	900 mm	510 kg	€ 3.975,-	€ 675,-

### Options

- Transparent cover-plate mounted on see-through grille (for grain etc.)
- Detachable frame (+20% content; not for products vulnerable to damage)
- Straight edges (not possible in combination with detachable frame)
- Bolted plastic wear strip 200x25 mm

€ 75,-

€ 650,-

€ 200,-

€ 575,-

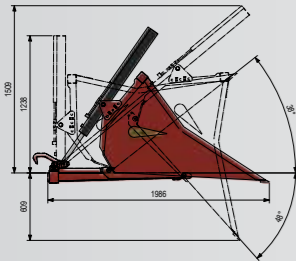

## LOADING BUCKET (FORK CARRIAGE MOUNTED)



HOD-150F

- Suitable for products vulnerable to damage
- Frame with rapid coupling FEM2 and FEM3 directly onto fork carriage
- See-through grille for optimal visibility
- 6 mm plate thickness
- Equipped with manganese wearing strip (80x15 mm)
- Including hydraulic hoses and quick connectors



HOD-150F

Type	Shovel width	Shovel depth	Shovel height	Volume	Center of Gravity	Weight	Price	Additional charge stainless steel soil
HOD-150F	1.500 mm	1.550 mm	850 mm	1.100 l	800 mm	400 kg	€ 4.100,-	€ 525,-
HOD-175F	1.750 mm	1.550 mm	850 mm	1.300 l	800 mm	435 kg	€ 4.200,-	€ 575,-
HOD-200F	2.000 mm	1.550 mm	850 mm	1.500 l	800 mm	470 kg	€ 4.300,-	€ 625,-
HOD-225F	2.250 mm	1.550 mm	850 mm	1.700 l	800 mm	505 kg	€ 4.400,-	€ 675,-

### Options

- Transparent cover-plate mounted on see-through grille (for grain etc.)
- Detachable frame (+20% content; not for products vulnerable to damage)
- Straight edges (not possible in combination with detachable frame)
- Bolted plastic wear strip 200x25 mm

€ 75,-

€ 650,-

€ 200,-

€ 575,-

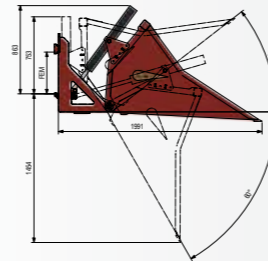

## LOADING BUCKET (HEAVY DUTY, FORK MOUNTED)



HOD-Z-250 RVS



- Suitable for products vulnerable to damage
- Double hinge device for a minimum of loss in dump height
- See-through grille for optimal visibility
- Bucket plate thickness 8 mm
- All pivots equipped with bearings
- Equipped with boron wearing strip (150x20 mm)
- Fork Sleeves: 153x69xL1197 mm, c.t.c. 830 mm
- Including hoses and quick connectors

HOD-Z-250



Type	Shovel width	Shovel depth	Shovel height	Volume	Center of Gravity	Weight	Price	Additional charge stainless steel soil
HOD-Z-200	2.000 mm	1.550 mm	850 mm	1.500 l	900 mm	650 kg	€ 5.850,-	€ 650,-
HOD-Z-225	2.250 mm	1.550 mm	850 mm	1.700 l	900 mm	675 kg	€ 5.975,-	€ 700,-
HOD-Z-250	2.500 mm	1.550 mm	850 mm	1.900 l	900 mm	700 kg	€ 6.625,-	€ 750,-
HOD-Z-275	2.750 mm	1.550 mm	850 mm	2.100 l	900 mm	725 kg	€ 6.850,-	€ 800,-

HOD-Z-200/225: 1 cylinder  
HOD-Z-250/275: 2 cylinders

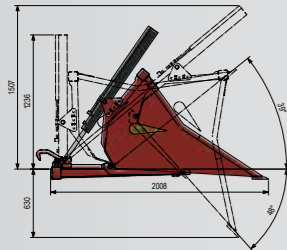

### Options

- Transparent cover-plate mounted on see-through grille (for grain etc.)
- Detachable frame (+20% content; not for products vulnerable to damage)
- Straight edges (not possible in combination with detachable frame)
- Bolted plastic wear strip 200x25 mm

€ 75,-  
€ 650,-  
€ 200,-  
€ 575,-

## LOADING BUCKET (HEAVY DUTY, FORK CARRIAGE MOUNTED)



HOD-Z-250F



- Suitable for products vulnerable to damage
- Frame with rapid coupling directly onto fork carriage
- See-through grille for optimal visibility
- 8 mm plate thickness
- All pivots equipped with bearings
- With boron wearing strip (150x20 mm)
- Complete with hoses and quick connectors

HOD-Z-250F



Type	Shovel width	Shovel depth	Shovel height	Volume	Center of Gravity	Weight	Price	Additional charge stainless steel soil
HOD-Z-200F	2.000 mm	1.550 mm	850 mm	1.500 l	800 mm	750 kg	€ 6.675,-	€ 650,-
HOD-Z-225F	2.250 mm	1.550 mm	850 mm	1.700 l	800 mm	795 kg	€ 6.900,-	€ 700,-
HOD-Z-250F	2.500 mm	1.550 mm	850 mm	1.900 l	800 mm	925 kg	€ 7.575,-	€ 750,-
HOD-Z-275F	2.750 mm	1.550 mm	850 mm	2.100 l	800 mm	970 kg	€ 7.800,-	€ 800,-

HOD-Z-200/225F: 1 cylinder, for fork carriage FEM2/3  
HOD-Z-250/275F: 2 cylinders, for fork carriage FEM3/4

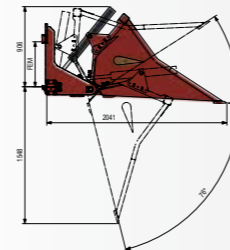

### Options

- Transparent cover-plate mounted on see-through grille (for grain etc.)
- Detachable frame (+20% content; not for products vulnerable to damage)
- Straight edges (not possible in combination with detachable frame)
- Bolted plastic wear strip 200x25 mm

€ 75,-  
€ 650,-  
€ 200,-  
€ 575,-



## LOADING BUCKET FOR REACH LOADERS



HOD-V-225



- Suitable for products vulnerable to damage
- Attachments for all reach loader brands available
- See-through grille for optimal visibility
- 10 mm plate thickness
- With boron wearing strip (150x20 mm)

HOD-V-225 JCB Quick-Fit



Type	Shovel width	Shovel depth	Shovel height	Volume	Center of Gravity	Weight	Price	Additional charge stainless steel soil
HOD-V-225	2.250 mm	1.550 mm	850 mm	1.700 l	520 mm	635 kg	€ 4.500,-	€ 700,-
HOD-V-250	2.500 mm	1.550 mm	850 mm	1.900 l	520 mm	680 kg	€ 4.750,-	€ 750,-
HOD-V-275	2.750 mm	1.550 mm	850 mm	2.100 l	520 mm	750 kg	€ 5.000,-	€ 800,-
HOD-V-300	3.000 mm	1.550 mm	850 mm	2.300 l	520 mm	795 kg	€ 5.250,-	€ 850,-

### Options

- Transparent cover-plate mounted on see-through grille (for grain etc.) € 125,-
- Detachable frame (+20% content; not for products vulnerable to damage) € 650,-
- Straight edges (not possible in combination with detachable frame) € 200,-
- Bolted plastic wear strip 200x25 mm € 575,-
- Attachment parts for reachtruck/shovel See page 85

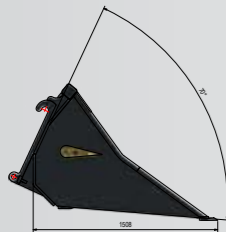

## OPTIONS POTATO LOADING BUCKETS

- 1 Straight edges
- 2 Bolted plastic wear strip
- 3 Detachable frame



## BULK LOADING BUCKET (FORK MOUNTED)



HO-150

- Suitable for bulk products such as cereals, fertiliser, soil, etc.
- Double hinge device for a minimum of loss in dump height
- 6 mm plate thickness
- With manganese wearing strip (80x15 mm)
- Fork Sleeves: 159x69-L1197 mm, c.t.c. 830 mm
- Complete with hydraulic hoses and quick connectors



HO-150

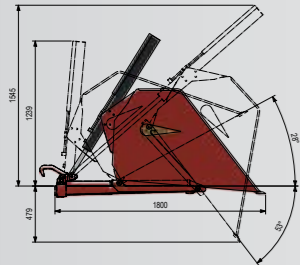

Type	Shovel width	Shovel depth	Shovel height	Volume	Center of Gravity	Weight	Price
HO-125	1.250 mm	1.300 mm	860 mm	900 l	800 mm	415 kg	€ 3.575,-
HO-150	1.500 mm	1.300 mm	860 mm	1.100 l	800 mm	445 kg	€ 3.675,-
HO-175	1.750 mm	1.300 mm	860 mm	1.300 l	800 mm	475 kg	€ 3.775,-
HO-200	2.000 mm	1.300 mm	860 mm	1.500 l	800 mm	505 kg	€ 3.875,-
HO-225	2.250 mm	1.300 mm	860 mm	1.700 l	800 mm	535 kg	€ 3.975,-

## BULK LOADING BUCKET (FORK CARRIAGE MOUNTED)



HO-125F

- Suitable for bulk products such as cereals, fertiliser, soil, etc.
- Frame with rapid coupling FEM2 and FEM3, directly onto fork carriage
- 6 mm plate thickness
- With manganese wearing strip (80x15 mm)
- Complete with hoses and quick connectors



HO-125F

Type	Shovel width	Shovel depth	Shovel height	Volume	Center of Gravity	Weight	Price
HO-125F	1.250 mm	1.300 mm	860 mm	900 l	645 mm	420 kg	€ 3.975,-
HO-150F	1.500 mm	1.300 mm	860 mm	1.100 l	645 mm	450 kg	€ 4.075,-
HO-175F	1.750 mm	1.300 mm	860 mm	1.300 l	645 mm	480 kg	€ 4.175,-
HO-200F	2.000 mm	1.300 mm	860 mm	1.500 l	645 mm	510 kg	€ 4.275,-
HO-225F	2.250 mm	1.300 mm	860 mm	1.700 l	645 mm	540 kg	€ 4.375,-

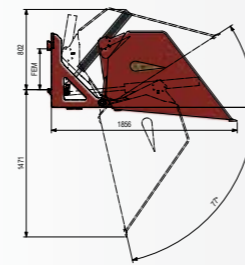

## BULK LOADING BUCKET (HEAVY DUTY, FORK MOUNTED)



HO-250-ZI

- Loading bucket for industrial applications
- Double hinge device for a minimum of loss in dump height
- All rotating points have bearings
- 8 mm plate thickness
- With boron wearing strip (150x20 mm)
- Fork Sleeves: 153x69x1197 mm, c.t.c. 830 mm
- Complete with hoses and quick connectors
- Equipped with 2 cylinders



HO-250-ZI

Type	Shovel width	Shovel depth	Shovel height	Volume	Center of Gravity	Weight	Price
HO-200-ZI	2.000 mm	1.465 mm	1.150 mm	1.950 l	920 mm	840 kg	€ 6.825,-
HO-225-ZI	2.250 mm	1.465 mm	1.150 mm	2.200 l	920 mm	890 kg	€ 7.000,-
HO-250-ZI	2.500 mm	1.465 mm	1.150 mm	2.450 l	920 mm	940 kg	€ 7.175,-
HO-275-ZI	2.750 mm	1.465 mm	1.150 mm	2.700 l	920 mm	990 kg	€ 7.350,-
HO-300-ZI	3.000 mm	1.465 mm	1.150 mm	2.950 l	920 mm	1.040 kg	€ 7.525,-

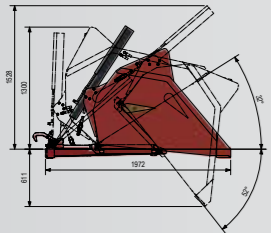

## BULK LOADING BUCKET (HEAVY DUTY, FORK CARRIAGE MOUNTED)



HO-250-ZIF

- Loading bucket for industrial applications
- Frame with rapid coupling FEM3 and FEM4 directly onto fork carriage
- Short attachment length to fork carriage
- All rotating points have bearings
- 8 mm plate thickness
- With boron wearing strip (150x20 mm)
- Complete with hoses and quick connectors
- Equipped with 2 cylinders



HO-250-ZIF

Type	Shovel width	Shovel depth	Shovel height	Volume	Center of Gravity	Weight	Price
HO-200-ZIF	2.000 mm	1.500 mm	1.100 mm	1.950 l	800 mm	920 kg	€ 7.850,-
HO-225-ZIF	2.250 mm	1.500 mm	1.100 mm	2.200 l	800 mm	970 kg	€ 8.025,-
HO-250-ZIF	2.500 mm	1.500 mm	1.100 mm	2.450 l	800 mm	1.020 kg	€ 8.200,-
HO-275-ZIF	2.750 mm	1.500 mm	1.100 mm	2.700 l	800 mm	1.070 kg	€ 8.375,-
HO-300-ZIF	3.000 mm	1.500 mm	1.100 mm	2.950 l	800 mm	1.120 kg	€ 8.550,-

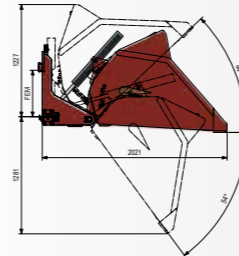

▶ Video

## MECHANICAL BUCKET (FORK MOUNTED)



MO-800

- Mechanical bucket for bulk products
- Handle can be placed on the right and left side
- Low loss on discharge
- 6 mm plate thickness
- With manganese wearing strip (80x15 mm)
- Fork Sleeves: 159x69-L1197 mm, c.t.c. 830 mm
- Maximum load 750 kg
- External skip width: + 130 mm



MO-800

Type	Shovel width	Shovel depth	Shovel height	Volume	Center of Gravity	Weight	Price
MO-600	1.000 mm	1.300 mm	600 mm	600 l	885 mm	290 kg	€ 2.100,-
MO-800	1.300 mm	1.300 mm	600 mm	800 l	885 mm	320 kg	€ 2.225,-
MO-1000	1.600 mm	1.300 mm	600 mm	1.000 l	885 mm	350 kg	€ 2.350,-

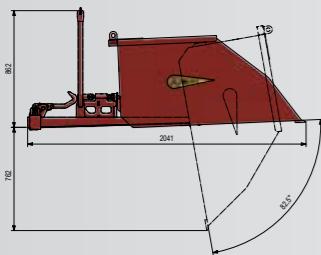

## HYDRAULIC BUCKET (FORK MOUNTED)



MO-150

- Bucket suitable for sand, gravel, soil etc.
- 5 mm plate thickness
- Fork Sleeves: 180x59-L800 mm, c.t.c. 760 mm
- Complete with hydraulic hoses and quick connectors



MO-150

Type	Shovel width	Shovel depth	Shovel height	Volume	Center of Gravity	Weight	Price
MO-100	1.000 mm	1.000 mm	560 mm	290 l	1.380 mm	180 kg	€ 2.200,-
MO-120	1.200 mm	1.000 mm	560 mm	350 l	1.380 mm	200 kg	€ 2.250,-
MO-150	1.500 mm	1.000 mm	560 mm	435 l	1.380 mm	230 kg	€ 2.300,-
MO-180	1.800 mm	1.000 mm	560 mm	525 l	1.380 mm	250 kg	€ 2.350,-

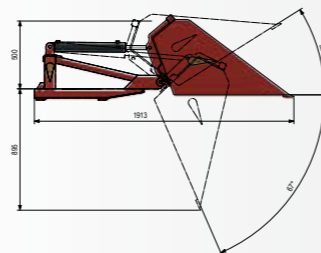

## TIPPING CONTAINER (FORK MOUNTED)



KC-1000

- Mechanical tipping container for removal of products, waste etc.
- Handle can be placed on the right or left side
- Low loss on discharge
- 4 mm plate thickness
- Fork Sleeves: 159x74-L990 mm, c.t.c. 735 mm
- Maximum load 750 kg
- External container width: +130 mm



KC-1000 + wheels

Type	Shovel width	Shovel depth	Shovel height	Volume	Center of Gravity	Weight	Price
KC-1000	1.000 mm	1.400 mm	820 mm	1.000 l	1.130 mm	250 kg	€ 1.825,-
KC-1300	1.300 mm	1.400 mm	820 mm	1.300 l	1.150 mm	280 kg	€ 1.925,-

### Options

- Wheels (2 fixed wheels and 2 braked swivel wheels)
- Hydraulic tippable
- Galvanized

€ 350,-  
 € 525,-  
 € 700,-

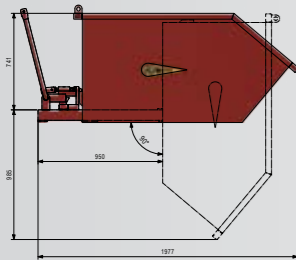

## LOADING BUCKET



VCB-240

- Robust, heavy duty construction
- With reinforcing strips for attachment parts

### Series A:

- Loading bucket suitable for front loaders
- 6 mm plate thickness
- With manganese wearing strip (80x15 mm)

### Series B:

- Loading bucket suitable for heavy duty front loaders and telehandlers
- 8 mm plate thickness
- With boron wearing strip (150x20 mm)



VCB-240 Euro

Type	Series	Shovel width	Shovel depth	Shovel height	Volume	Weight	Price
6b	A	1.400 mm	850 mm	650 mm	470 l	160 kg	€ 1.000,-
21b	A	1.800 mm	850 mm	650 mm	600 l	180 kg	€ 1.050,-
21b-2	A	2.000 mm	850 mm	650 mm	665 l	200 kg	€ 1.100,-
22b	A	2.200 mm	850 mm	650 mm	730 l	220 kg	€ 1.150,-
VCB-200	B	2.000 mm	850 mm	650 mm	665 l	325 kg	€ 1.950,-
VCB-220	B	2.200 mm	850 mm	650 mm	730 l	350 kg	€ 2.050,-
VCB-240	B	2.400 mm	850 mm	650 mm	795 l	375 kg	€ 2.150,-

### Options

- Euro connection
- Attachment parts for frontloader/telehandler/shovel

€ 125,-  
 See page 85



## HYDRAULIC GRAPPLE BUCKET



THG-220 Euro



- With boron wearing strip (150x20 mm)
- Equipped with very heavy cylinders attached to upper claw
- Complete with hydraulic hoses and quick connectors

### THG serie:

- Suitable for front loaders, telehandlers and articulated loaders
- 8 mm plate thickness
- Tine thickness 20 mm

### ZBG serie:

- Suitable for telehandlers and shovels
- 10 mm plate thickness
- Tine thickness 25 mm

ZBG-260 Claas Kramer

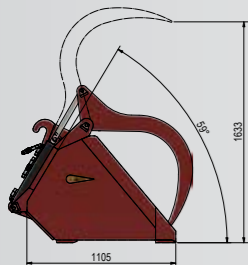

Type	Shovel width	Shovel depth	Shovel height	Volume	Number of teeth	weight	Price
THG-180	1.800 mm	850 mm	650 mm	600 l	7	475 kg	€ 3.850,-
THG-200	2.000 mm	850 mm	650 mm	665 l	8	515 kg	€ 4.100,-
THG-220	2.200 mm	850 mm	650 mm	730 l	8	550 kg	€ 4.350,-
THG-240	2.400 mm	850 mm	650 mm	795 l	9	600 kg	€ 4.600,-
ZBG-200	2.000 mm	1.100 mm	850 mm	1.000 l	7	800 kg	€ 6.375,-
ZBG-220	2.200 mm	1.100 mm	850 mm	1.100 l	7	850 kg	€ 6.575,-
ZBG-240	2.400 mm	1.100 mm	850 mm	1.200 l	8	900 kg	€ 6.775,-
ZBG-260	2.600 mm	1.100 mm	850 mm	1.300 l	8	950 kg	€ 6.975,-

### Options

- Euro attachment (not suitable with ZBG serie)
- Attachment parts for frontloader/telehandler/shovel

€ 125,-  
See page 85

## SIDESHIFTS | FORK POSITIONER

DSD-Z-300



## THREE-POINT LINKAGE SIDE-SHIFT (PTO)



DSD-500

- For shifting PTO driven 3-point linkage equipment
- 3-point linkage, DSD-500: Cat. 2, DSD-600: Cat. 2 and 3
- Adjustable lower link hooks, DSD-500: Cat. 2, DSD-600: Cat. 2 or 3
- Complete with hydraulic hoses and quick connectors



DSD-600

Type	Maximum load	Height	Sideshift reach	Weight	Price Cat. 2*	Price Cat. 3*
DSD-500	1.500 kg	850 mm	500 mm	230 kg	€ 3.250,-	-
DSD-600	3.000 kg	1.100 mm	600 mm	475 kg	€ 5.875,-	€ 6.000,-

\* 3-point linkage attachment side



DSD-600

### Options

- GPS ready

On request

## THREE-POINT LINKAGE SIDE-SHIFT (HEAVY DUTY)



DSD-Z-500

- Sideshift for 3-point linkage equipment
- 3-point linkage attachment: Cat. 2 and Cat. 3
- Standard sideshift reach: 500 mm
- Side-shift guides have bearings over hard-chromed shafts
- Fixed lower link hooks (Cat. 2 or Cat. 3) with automatic safety interlock
- Complete with hydraulic hoses and quick connectors



DSD-Z-500

Type	Maximum load	Height	Sideshift reach	Weight	Price Cat. 2*	Price Cat. 3*
DSD-Z-500	4.000 kg	915 mm	500 mm	400 kg	€ 6.375,-	€ 6.475,-

\* 3-point linkage attachment side



DSD-Z-500

### Options

- GPS ready

On request

## SMART CAMERA SIDE-SHIFT (THREE-POINT LINKAGE, HEAVY DUTY)



DSD-Z-300



DSD-Z-300



DSD-Z-300

- Camera-controlled sideshift for weeding e.g. corn, beets and onions
  - Precise weeding at high speeds up to 20 km/h
  - Standard with load-bearing gauge wheels for track widths from 1.5 m - 2.25 m (optional to 3,20 m)
  - Total sideshift range of 300 mm
  - Linear shift across hard chromed axes
  - Equipped with high resolution camera and color recognition
- 
- 3-point hitch: Cat. 2 and 3 (machine side)
  - Bolted, in height adjustable, catch hooks (Cat. 2) with automatic safety lock (tool side)
  - Suitable in combination with any type of weeder



▶ Video

Type	Maximum load	Height	Sideshift reach	Weight	Price
DSD-Z-300	4.000 kg	1625 mm	300 mm	400 kg	€ 26.950,-

**i** Other terms and conditions apply to the Smart Camera Sideshift

### Options

- LED work lights for optimal crop recognition € 550,-
  - Manual joystick control € 750,-
  - Support wheels up to 3.20 m € 500,-
- 
- Without stabilizing wheels and attachments (front linkage) Less price  
- € 750,-

DSD-Z-300

DSD-Z-300



## DSD-Z-300

- 1** High-resolution camera with color recognition
- 2** Linear shift across hard chromed axes
- 3** Total sideshift range of 300 mm

SMART CAMERA SIDE-SHIFT



## SIDE-SHIFT FOR FORKLIFT AND TELEHANDLER



HSR-2

- Heavy duty side-shift
- Standard side-shift stroke 300 mm
- Side-shift guides have bearings over hard-chromed shafts
- Including hydraulic hoses and quick connectors
- Excluding forklift forks



HSR-2

Type	Maximum load	Height of the fork carrier	Frontal extension length	Center of Gravity	Fork carrier width	Weight	Price
HSR-2	2.500 kg	FEM2: 407 mm	140 mm	65 mm	1.200 mm	235 kg	€ 3.100,-
HSR-3	3.500 kg	FEM3: 508 mm	150 mm	70 mm	1.200 mm	260 kg	€ 3.550,-

### Options

- Different side-shift stroke
- Attachment parts for frontloader/reachtruck

On request  
See page 85

## FORK POSITIONER



WV-35

- Heavy duty fork positioner
- Fork guides have bearings over hard-chromed shafts
- Including detachable forks
- Adjustment range 280-980 mm centres
- Frame width 1190 mm
- Including hydraulic hoses and quick connectors



WV-35

Type	Maximum load	Fork size	Height of the fork carrier	Frontal extension length	Center of Gravity	Weight	Price
WV-25	2.500 kg	FEM2A 100x40x1200 mm	FEM2: 407 mm	170 mm	180 mm	270 kg	€ 4.500,-
WV-35	3.500 kg	FEM3A 125x45x1200 mm	FEM3: 508 mm	190 mm	185 mm	340 kg	€ 4.850,-

**i** Adjustment range and frame width can be adjusted on request. Ask for the possibilities!

### Options

- Integrated sideshift (beware, four-hose connection)
- Attachment parts for frontloader/reachtruck

€ 550,-  
See page 85



WV-35 Giant

BP-3



## BALE CLAMPS | BALE SPEAR

 **VIDEO**  
Scan the QR code



## BALE CLAMP FOR RECTANGULAR BALES



BKP-UF Euro



- Compact baleclamp for wrapped rectangular bales
- Also suitable for round bales
- Heavy duty clamp arms made out of thick-walled tubing
- Narrow clamp arm allows passage between close-lying bales
- With rased rear section for second bale
- With controlled non-return valve and pressure relief valve as standard (ex mill at 140 bar)
- Including hydraulic hoses and quick connectors

BKP-UF Euro



Type	Number of bales	Clamp reach	Min. machine width	Length clamping arm	Max. capacity	Weight	Price
BKP-UF	1 + 1	750-2.050 mm	1.150 mm	1.100 mm	1.500 kg	325 kg	€ 2.850,-

### Options

- Front loader connection (euro)
- Three-point hitch (cat. 2) connection
- FEM2 connection
- FEM3 connection
- Attachment parts for frontloader/telehandler/shovel

€ 225,-

€ 225,-

€ 225,-

€ 250,-

See page 85

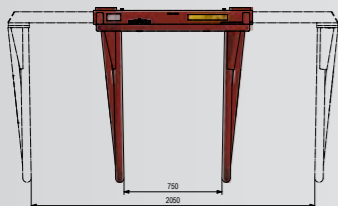

## BALE CLAMP FOR ROUND BALES



BKP Euro



- Bale clamp for round bales only
- Heavy duty baleclamp arm made out of thick walled tubing
- Clamp arms optimally curved
- With controlled non-return valve and pressure relief valve as standard (ex mill at 170 bar)
- Including hydraulic hoses and quick connectors

BKP Euro



Type	Number of bales	Bale diameter	Max. capacity	Weight	Price
BKP	1	900-1.300 mm	1.500 kg	250 kg	€ 2.400,-

### Options

- Front loader connection (euro)
- Three-point hitch (cat. 2) connection
- FEM2 connection
- FEM3 connection
- Attachment parts for frontloader/telehandler/shovel



▶ Video

€ 225,-

€ 225,-

€ 225,-

€ 250,-

See page 85

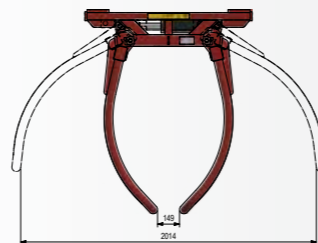

## BALE SPEAR



BP-3 Euro

- Bale spear suitable for both round and rectangular bales
- Universal mainframe with up to 5 threaded spears



BP-3 Euro + Raised rear section

Type	Width	Spears	Spear distance center to center	Max. capacity	Weight	Price
BP-2	1.500 mm	2 x Ø45-L980 mm	720/1430 mm	1.000 kg	95 kg	€ 800,-
BP-3	1.500 mm	3 x Ø45-L980 mm	360/720 mm	1.500 kg	105 kg	€ 900,-
BP-5	1.500 mm	5 x Ø45-L980 mm	360 mm	1.500 kg	125 kg	€ 1.100,-

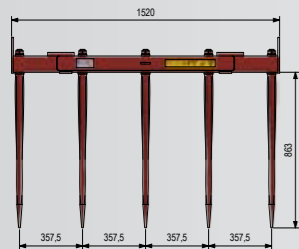

### Options

- Front loader connection (euro) € 225,-
- Three-point hitch (cat. 2) connection € 225,-
- FEM2 connection € 225,-
- FEM3 connection € 250,-
- Raised rear section (2000 mm) € 225,-
- Straw bale clamp (incl. raised rear section) € 925,-
- Spear length 1250 mm instead of 980 mm (per spear) € 35,-
- Attachment parts for frontloader/telehandler

See page 85

## LIFTING MASTS AND PALLET CARRIERS



## LIFTING MAST



HM280/1600

- With category 2 three-point linkage as standard
- Mast width 525 mm
- Fork carriage width 1000 mm (FEM2)
- Fork length 1190 mm (foldaway)
- Adjustable fork width
- Lifting capacity calculated at 180 bar
- Drive-through height calculated with lower hitch point height 300 mm above the ground
- With wagon drawbar
- Complete with hydraulic hoses and quick connectors

**i** This type of lifting mast is not suitable in combination with a bale clamp, box rotator etc.



HM280/1600

Type	Lift height	Lifting capacity	Headroom	Weight	Price
HM200/1000	2.000 mm	1.000 kg	1.800 mm	370 kg	€ 4.325,-
HM240/1000	2.400 mm	1.000 kg	2.000 mm	385 kg	€ 4.425,-
HM280/1000	2.800 mm	1.000 kg	2.200 mm	400 kg	€ 4.525,-
HM200/1600	2.000 mm	1.600 kg	1.800 mm	380 kg	€ 4.450,-
HM240/1600	2.400 mm	1.600 kg	2.000 mm	395 kg	€ 4.550,-
HM280/1600	2.800 mm	1.600 kg	2.200 mm	410 kg	€ 4.650,-

### Options

- Lifting mast accessories

See page 57

## LIFTING MAST (SEE-THROUGH MODEL)



HMD 240/2000

- With category 2 three-point linkage as standard
- Mast width 770 mm
- Fork carriage width 1200 mm (FEM2)
- Fork length 1190 mm (foldaway)
- Adjustable fork width
- Lifting capacity calculated at 180 bar
- Drive-through height calculated with lower hitch point height 300 mm above the ground
- With wagon drawbar
- Complete with hydraulic hoses and quick connectors

**i** Tractor specifications desired for solid construction of the lifting mast on the front of the tractor.  
This type of lifting mast is not suitable in combination with a forward tipping box rotator.



HMD 240/2000

Type	Lift height	Lifting capacity	Headroom	Weight	Price
HMD 200/2000	2.000 mm	2.000 kg	1.800 mm	595 kg	€ 6.350,-
HMD 240/2000	2.400 mm	2.000 kg	2.000 mm	615 kg	€ 6.450,-
HMD 280/2000	2.800 mm	2.000 kg	2.200 mm	635 kg	€ 6.550,-
HMD 240/2500	2.400 mm	2.500 kg	2.000 mm	625 kg	€ 6.775,-
HMD 280/2500	2.800 mm	2.500 kg	2.200 mm	645 kg	€ 6.875,-
HMD 340/2500	3.400 mm	2.500 kg	2.500 mm	680 kg	€ 7.050,-
HMD 400/2500	4.000 mm	2.500 kg	2.800 mm	710 kg	€ 7.225,-

### Options

- Solid construction of liftingmast on front of the tractor instead of three-point
- Lifting mast accessories

€ 200,-  
See page 57

## LIFTING MAST (SEE-THROUGH MODEL, HEAVY DUTY)



HMZ 400/3000



- With category 2 three-point linkage as standard
- Mast width 720 mm
- Fork carriage width 1200 mm (FEM3)
- Fork length 1190 mm (foldaway)
- Adjustable fork width
- Lifting capacity calculated at 180 bar
- Drive-through height calculated with lower hitch point height 350 mm above the ground
- Complete with hydraulic hoses and quick connectors

**i** This type of lifting mast is suitable in combination with the tipping box rotator.

HMZ 400/3000



Type	Hefhoogte	Hefcapaciteit	Doorrijhoogte	Gewicht	Prijs
HMZ 280/3000	2.800 mm	3.000 kg	2.220 mm	820 kg	€ 11.250,-
HMZ 340/3000	3.400 mm	3.000 kg	2.520 mm	870 kg	€ 11.500,-
HMZ 400/3000	4.000 mm	3.000 kg	2.830 mm	920 kg	€ 11.750,-

### Options

- Lifting mast accessories

See page 57

## ACCESSORIES FOR LIFTING MASTS

Neigcilinder



Hydraulische aansluiting



3 voudig stuurventiel



Option	Description	Price
Tilting cylinder (HM)	Piston diameter 50 mm, stroke 200 mm, retracted length center to center 460 mm, with hoses, for lifting masts till 1600kg, including balancing valve. (Cat. 2 - Cat. 2)	€ 325,-
Tilting cylinder (HMD and HMZ)	Piston diameter 60 mm, stroke 250 mm, retracted length center to center 510 mm, with hoses, for lifting masts till 3000kg, including balancing valve. (Cat. 2 - Cat. 2)	€ 350,-
Sideshift (HM and HMD)	Piston diameter 60 mm, stroke 250 mm, retracted length center to center 510 mm, with hoses, for lifting masts till 3000kg, including balancing valve. (Cat. 2 - Cat. 3)	€ 350,-
Sideshift (HM/HMD)	FEM2 Sideshift on fork carriage, stroke 200 mm (fork carriage width 1000 mm (HM), 1200 mm (HMD)), including hydraulic connection on fork carriage	€ 1.100,-
Sideshift (HMZ)	FEM3 Sideshift on fork carriage, stroke 200 mm (fork carriage width 1200 mm) Including hydraulic connection on fork carriage	€ 1.450,-
Hydraulic connection	Double-action hydraulic connection on fork carriage	€ 325,-
Hydraulic boxclamp	Hydraulic boxclamp, adjustable from 1250 to 2250 mm	€ 1.900,-
Accumulator	Accumulator (for shock absorption, ex mill at 30 bar)	€ 175,-

Description	Manual on lifting mast	Joystick operated (circulation)
Dual control valve with hoses	€ 550,-	€ 1.750,-
Triple control valve with hoses	€ 625,-	€ 2.200,-
Fourfold control valve with hoses	€ 750,-	€ 2.575,-

## PALLET CARRIER WITH FIXED FORKS



P46B

- Pallet carrier suitable for transport of all types and sizes of pallets and boxes
- Strong, robust frame



P46B

Type	Maximum load	Fork length	Height	Three-point hitch attachment	Fork distance (center to center)	Weight	Price
P46	1.300 kg	1.000 mm	710 mm	Cat. 1	590 mm	55 kg	€ 600,-
P46A	1.800 kg	1.190 mm	950 mm	Cat. 2	730 mm	90 kg	€ 750,-
P46B	2.500 kg	1.190 mm	950 mm	Cat. 2	730 mm	170 kg	€ 1.050,-

### Options

- Removable raised rear rack (P46: 1500 mm, € 175,- P46A/B 1750 mm) € 200,-

## PALLET CARRIER WITH ADJUSTABLE FORKS



PF25 Driepunt



PF25 Driepunt



PF25 Driepunt

- Pallet carrier suitable for transport of pallets and boxes
- Strong, robust frame
- With FEM 2/3/4 fork carriage
- **Beware. Standard without attachment parts and forklift forks. See options.**

Type	Maximum load	Height of the fork carrier (FEM)	Fork carrier width	Weight	Price
PF25	2.500 kg	FEM2: 407 mm	1.200 mm	85 kg	€ 725,-
PF35	3.500 kg	FEM3: 508 mm	1.200 mm	115 kg	€ 875,-
PF45	5.000 kg	FEM4: 635 mm	1.200 mm	150 kg	€ 1.200,-

### Options

- Front loader connection (euro) € 225,-
- Three-point hitch (cat. 2) connection € 225,-
- Rapid coupling FEM2 or FEM3 € 400,-
- Attachment parts for frontloader/reachtruck/shovel See page 85

Type forklift forks	Dimensions forks	Suitable for	Maximum load	Weight per set	Price
Vast	FEM2A 100x40x1200 mm	PF25	2.500 kg	95 kg	€ 475,-
Vast	FEM3A 125x45x1200 mm	PF35	3.500 kg	150 kg	€ 675,-
Vast	FEM4A 150x60x1200 mm	PF45	5.000 kg	190 kg	€ 1.150,-
Opklapbaar	100x50x1200 mm	PF25	2.500 kg	140 kg	€ 1.050,-
Opklapbaar	100x50x1200 mm	PF35	3.500 kg	170 kg	€ 1.175,-

## TILLAGE EQUIPMENT



**LOOKING FOR SPECIFIC PARTS?**  
We like to help you!

+31 (0)518 745038

spareparts@wifo.nl

+31 (0)518 411318



## CULTIVATOR (WORKING DEPTH 500 MM)



KS200



- Screwable and in width adjustable tine mounting
- Tine thickness: 25 mm, with shearing bolt protection
- Shares can be replaced using bolt fixing
- Standard share width 60 mm
- Cat. 2 linkage
- Executable with crumble-/pressure roller

KS-300 + crumble role



Type	Working width	Number of teeth	Weight	Price
KS200	2.250 mm	7	480 kg	€ 3.500,-
KS250	2.750 mm	9	560 kg	€ 4.100,-
KS300	3.250 mm	11	640 kg	€ 4.700,-

### Crumble role (with screwable mounting and depth adjustment)

- Crumble role Ø610-2250 mm with depth adjustment for KS200 € 2.825,-
- Crumble role Ø610-2750 mm with depth adjustment for KS250 € 2.925,-
- Crumble role Ø610-3250 mm with depth adjustment for KS300 € 3.025,-

### Options

- Share 150 mm for TSB(-R)25 tine, € 20,- (additional price per share)
- Goose foot 300 mm width for Tsb and Tsb-R tine, € 30,- (additional price per share)
- Working depth 600 mm instead of 500 mm, per tine € 30,- (additional price per tine)
- Set depth wheels 195/65-R15, adjustable height € 920,-

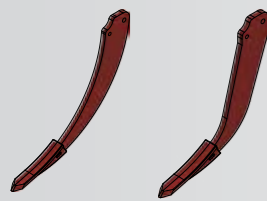

Tsb25

Tsb-R25

## SUBSOILER (WORKING DEPTH 400 MM)



WKT3



- Subsoiler suitable for horticultural purposes
- Maximal free space in the frame
- Outer tines are mounted with bolths and in width adjustable (max. 110 cm)
- Tine thickness: 20 mm, with shearing bolt protection
- Shares can be replaced using bolt fixing
- Standard share width 50 mm
- Cat. 1 linkage

WKT3



Type	Number of teeth	Max. tooth distance	Weight	Price
WKT2	2	1.100 mm	80 kg	€ 1.375,-
WKT3	3	550 mm	100 kg	€ 1.550,-
WKT4	4	360 mm	120 kg	€ 1.725,-

### Options

- Goose foot 250 mm width for Tsb(-R)20 tine € 25,- (additional price per share)

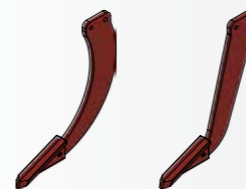

Tsb20

Tsb-R20

## SUBSOILER (WORKING DEPTH 500 MM)



WK3



- Subsoiler suitable for opening up of traces
- Heavy and solid framework
- Maximal free space in the frame
- Outer tines are mounted with bolths and in width adjustable
- Tine thickness: 25 mm, with shearing bolt protection
- Shares can be replaced using bolt fixing
- Standard share width 60 mm
- Cat. 1 and 2 linkage

WK3



Type	Number of teeth	Max. tooth distance	Weight	Price
WK2	2	1.600 mm	170 kg	€ 1.625,-
WK3	3	800 mm	185 kg	€ 1.850,-

### Options

- Share 150 mm for TSB(-R)25 tine, per share
- Goose foot 300 mm width for Tsb(-R)25 tine
- Maximum depth 600 mm instead of 500 mm

€ 20,- (additional price per share)

€ 30,- (additional price per share)

€ 30,- (additional price per tine)



Tsb25



Tsb-R25

## SUBSOILER (WORKING DEPTH 700 MM)



WU23-150



- Subsoiler for tough circumstances
- Heavy duty robust frame
- Tines are provided with shearing bolt protection
- Tine thickness 30 mm
- Replacable shares (width 200 mm) for bent and straight tines
- Replacable shares (width 130 mm) for Flevo tine
- Outer tines of the WU22-V and WU23-V are adjustable in width
- Cat. 2 linkage as a standard

WU22-V



Type	Number of teeth	Tooth distance	Weight	Price with bend teeth	Price with straight teeth	Price with Flevo teeth
WU11	1		210 kg	€ 1.825,-	€ 1.900,-	€ 1.825,-
WU22-150	2	1.500 mm	375 kg	€ 2.950,-	€ 3.100,-	€ 2.950,-
WU22-180	2	1.800 mm	390 kg	€ 3.000,-	€ 3.150,-	€ 3.000,-
WU22-V	2	1.500-2.250 mm	545 kg	€ 3.950,-	€ 4.100,-	€ 3.950,-
WU23-150	3	750 mm	435 kg	€ 3.325,-	€ 3.550,-	€ 3.325,-
WU23-180	3	900 mm	445 kg	€ 3.400,-	€ 3.625,-	€ 3.400,-
WU23-V	3	725-1.125 mm	600 kg	€ 4.225,-	€ 4.450,-	€ 4.225,-

### Crumble role (with screwable mounting and depth adjustment)

- Crumble role Ø610-2050 mm with depth adjustment for WU22/23-150 € 2.725,-
- Crumble role Ø610-2250 mm with depth adjustment for WU22/23-180 € 2.825,-
- Crumble role Ø610-2750 mm with depth adjustment for WU22-V/WU23-V € 2.925,-

### Options

- Working depth 850 mm instead of 700 mm (not possible with Flevo tine) € 60,- (additional price per tine)
- Share 350 mm instead of 200 mm € 25,- (additional price per share)



Curved  
tine



Straight  
tine



Flevo  
tine

## SUBSOILER (WORKING DEPTH 700 MM)



WV35



- Subsoiler for tough circumstances
- Heavy duty robust frame in V-shape
- Working width: 3500 mm, frame width: 3175 mm
- Tines are provided with shearing bolt protection
- Tine thickness 30 mm
- Replacable shares (width 200 mm) for bent and straight tines
- Cat. 3 linkage as a standard

WV37 + verkrummelelol



Type	Number of teeth	Tooth distance	Weight	Price with bent teeth	Price with straight teeth
WV35	5	750 mm	760 kg	€ 7.100,-	€ 7.400,-
WV37	7	500 mm	895 kg	€ 7.850,-	€ 8.250,-

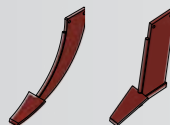

Curved tine      Straight tine

### Crumble role (incl. attachment on subsoiler)

- Crumble role Ø610 2x1750 mm with depth adjustment

€ 4.225,-

### Options

- Working depth 850 mm instead of 700 mm
- Share 350 mm instead of 200 mm
- Width marking and lighting

€ 60,- (additional price per tine)

€ 25,- (additional price per share)

€ 400,-

## RUBBERSCHUIVEN

MKS275-S



## RUBBER SCRAPER



MS275-S



- Rubber scraper for use on farmyard, roads, stables, etc.
- With rubber (35 mm thick)
- Rubber is reversible
- Standard model can be used both on tractor three-point linkage (cat. 2) and forklift
- When using a Euro connection, the tractor three-point linkage (cat. 2) and forklift connection can't be used anymore
- Type MS-275-DV(H) is adjustable to the left or right side, up to a max. of 45°
- Fork Sleeves: MS275-S(Z)/MS275-DV(H): 150x50-L340 mm, c.t.c. 800 mm

MS275-S



Type	Attachment	Description	Working width	Weight	Price
MS275-S	Driepunt	Vaste uitvoering	2.650 mm	145 kg	€ 900,-
MS275-SV	Euro	Vaste uitvoering	2.650 mm	145 kg	€ 1.150,-
MS275-DV	Driepunt	Draaibaar verstek	2.650 mm	235 kg	€ 2.075,-
MS275-DVW	Euro	Draaibaar verstek	2.650 mm	235 kg	€ 2.325,-
MS275-DVH	Driepunt	Hydr. draaibaar verstek	2.650 mm	260 kg	€ 2.675,-
MS275-DVHV	Euro	Hydr. draaibaar verstek	2.650 mm	260 kg	€ 2.925,-

MS275-DVH



- Rubber reinforced with canvas (2750x400x35 mm), including bolts € 375,-

## RUBBER SCRAPER (FORK MOUNTED)



MS275-H



- Rubber scraper for use on farmyard, roads, stables, etc.
- Equipped with hardwearing rubber: (35 mm thick)
- Suitable for mounting on the forks of the forklift
- Fork Sleeves: 150x66-L800 mm, c.t.c. 800 mm
- Rubber is reversible

MS275-H



Type	Description	Working width	Weight	Price
MS210-H	Vaste uitvoering	2.000 mm	135 kg	€ 850,-
MS275-H	Vaste uitvoering	2.650 mm	150 kg	€ 900,-
MS210-HV	Mech. draaibaar in 3 standen	2.000 mm	158 kg	€ 1.450,-
MS275-HV	Mech. draaibaar in 3 standen	2.650 mm	173 kg	€ 1.550,-
MS210-HVH	Hydr. draaibaar	2.000 mm	193 kg	€ 1.950,-
MS275-HVH	Hydr. draaibaar	2.650 mm	208 kg	€ 2.050,-

- Rubber reinforced with canvas (2100x400x35 mm), including bolts € 350,-
- Rubber reinforced with canvas (2750x400x35 mm), including bolts € 375,-

## RUBBER SCRAPER FOR REACH LOADER/SHOVEL



MS275-UZH Euro



- Heavy duty rubber scraper for use on farmyard, roads, stables, etc.
- Equipped with rubber (thickness appr. 35 mm)
- Heavy-duty scraper suitable for attachment to telehandler or shovel
- MS275/325-UZH are following the surface by a reciprocating frame
- Equipped with a bend snowblade as a standard (height 350 mm)
- Rubber is reversible
- Type MS-275/325-UZH are adjustable to the left and right, up to 41°
- Equipped with adjustable ends (in 2 positions)
- **Beware. Standard without attachment parts**

MS275-UZ Bobcat



Type	Description	Working width	Weight	Price
MS275-UZ	Fixed model	2.650 mm	230 kg	€ 1.050,-
MS325-UZ	Fixed model	3.150 mm	265 kg	€ 1.275,-
MS275-UZH	Hydr. rotatable	2.650 mm	300 kg	€ 3.575,-
MS325-UZH	Hydr. rotatable	3.150 mm	335 kg	€ 3.800,-

MS275-UZ Mailleux



- Rubber reinforced with canvas (2750x400x35 mm), including bolts
- Rubber reinforced with canvas (3250x400x35 mm), including bolts
- Attachment parts for frontloader/telehandler/shovel

€ 375,-

€ 425,-

See page 85

## TOOL CARRIERS

WDH-V



## TOOL CARRIER FOR 3-POINT HITCH EQUIPMENT



WDH-V



- Tool carrier for moving 3-point hitch (Cat. 2 and Cat. 3) equipment
- Toplink pin in height adjustable in three positions
- The type WDH-VZ is equipped with a tipper pin and catch hooks for semi-mounted machines
- Fork sleeves WDH-V: 150x66-L800 mm, c.t.c. 730 mm
- Fork sleeves WDH-VZ: 150x66-L1000 mm, c.t.c. 730 mm

WDH-VZ



Type	Max. capacity	Weight	Price
WDH-V	1.500 kg	85 kg	€ 925,-
WDH-VZ	2.500 kg	150 kg	€ 1.350,-

### Options

- Tipper hitch pin Ø35 / tow ball coupler K50 combination for WDH-VZ (detachable)
- Tow ball coupler K80 for WDH-VZ (detachable)
- Attachment parts for frontloader/telehandler/shovel

€ 125,-

€ 525,-

On request

Tipper hitch pin / tow ball coupler



## WDH-VZ

WDH-VZ



## TOOL CARRIER FOR 3-POINT HITCH EQUIPMENT (HEAVY DUTY)



WDH-VSZ

- Heavy-duty tool carrier for moving three-point (Cat. 2 and Cat. 3) equipment
- Toplink pin height adjustable in three positions
- Equipped with a tipper pin and catch hooks for semi-mounted machines
- Fork sleeves: 215x75-L1200 mm, h.o.h. 900 mm



WDH-VSZ

Type	Max. capacity	Weight	Price
WDH-VSZ	5.000 kg	280 kg	€ 1975,-

### Options

- Tow ball coupler K50 (detachable)
- Tow ball coupler K80 (detachable)
- Attachment parts for telehandler/shovel

€ 175,-

€ 550,-

On request

## WDH-VSZ



**VIDEO**  
Scan the QR-code



## DRAINAGE MACHINE



**VIDEO**  
Scan the QR-code



DM-160

## DRAINAGE MACHINE



DM-160



DM-160



DM-160

- Compact drainage machine for fully trenchless drainage
- Minimal damage and mixing of soil layers
- Standard Cat. 3 coupling
- Easy to transport
- Drainage speed: +/- 4 km per hour
- Preparation for GPS or laser control
- Minimum required power: 300 hp
- Slanted manganese knife
- Centering the knife through hydraulic draw line adjustment
- Simple absorption of drainage roll by a hydraulic reel
- For cables and drainage pipes up to Ø80 mm (outside)
- Complete with hoses and quick connectors
- **Depth control by double acting lifting device**

Type	Max. working depth	Number of teeth	Machine width	Weight	Price
DM-160	1400 mm	1	2.755 m	2.450 kg	On request

**i** Different configurations on request  
Other terms and conditions apply to the drainage machine





## TILTING FRAME



FE-300

- Tilting frame for mounting equipment with Euro attachment to forklifter
- Including euro rapid coupling
- Complete with hydraulic hoses and quick connectors

### FE-200

- With rapid coupling to FEM2 or FEM3 fork carriage
- Tilting angle: -30°/+88°

### FE-300

- With rapid coupling to FEM3 or FEM4 fork carriage
- Tilting angle: -22°/+88°



FE-300

Type	Width	Maximum load	Frontal extension length	Center of Gravity	Weight	Price
FE-200	1.200 mm	1.600 kg	280 mm	100 mm	175 kg	€ 3.950,-
FE-300	1.270 mm	3.000 kg	450 mm	195 mm	370 kg	€ 4.775,-

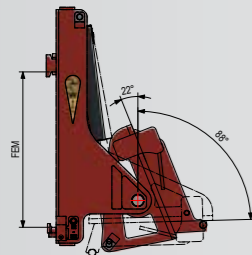

### Options

- Equipment attachment for telehandler and shovel

See page 85

## WEIGHING EQUIPMENT



WI-5000T

- Weighing equipment suitable for weighing artificial fertilisers, roughage, pallets, cattle, etc.
- Very compact construction; little loss through attachment
- With three-point quick connection system
- Equipped with three electronic weighing elements
- Weighing computer with zero point and tare setting
- Automatic zeroing, configurable read-out units from 10 gram to 100 kg
- Cat. 2 linkage



WI-5000T

Type	Width	Max. capacity	Max. measuring deviation	Extension loss	Weight	Price
WI-5000T	1.200 mm	5.000 kg	1%	115-155 mm	115 kg	€ 4.425,-

### Options

- Welded extension triangle
- Cable Weighing display 9,0 m instead of 4,5 m
- Isobus ready

€ 175,-

€ 30,-

On request

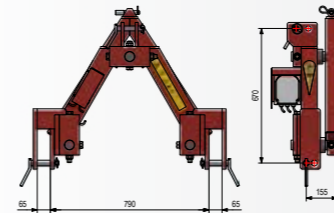

# ADAPTERS



Euro - Giant



- Suitable when attachment parts do not match with attachment on tractor, fork lift, reach loader, etc.

## MOST SOLD ADAPTORS

Machineside	Equipment side	Price
Maniscopic	Three-point hitch Cat. 3 Walterscheid	€ 2.100,-
Euro	Three-point hitch Cat. 2 Walterscheid	€ 1.750,-
JCB Quick-Fit	Three-point hitch Cat. 2 Walterscheid	€ 1.975,-
Merlo	Euro rapid coupling	€ 1.275,-
JCB Quick-Fit	Euro rapid coupling	€ 1.300,-
Driepunt Cat. 2	Euro rapid coupling	€ 1.075,-
Volvo L70	JCB Quick-Fit	€ 1.400,-
Volvo L70	Three-point hitch Cat. 3 Walterscheid	€ 1.675,-

Prices for other adapters on request

**i** Are you looking for a specific adapter? Contact us for the possibilities.

Euro - Three-point hitch



Merlo ZM2 - Mailleux (hydraulic)

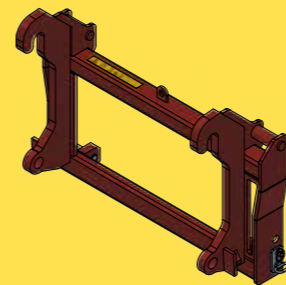

Adaptor Volvo L70 - JCB Quick-Fit

**Machineside**  
Volvo L70  
**Equipment side**  
JCB Quick-Fit

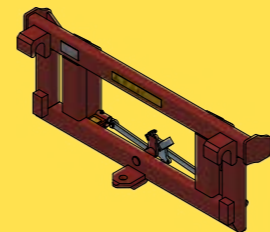

Adaptor Merlo ZM2 - Euro rapid coupling

**Machineside**  
Merlo ZM2  
**Equipment side**  
Euro rapid coupling

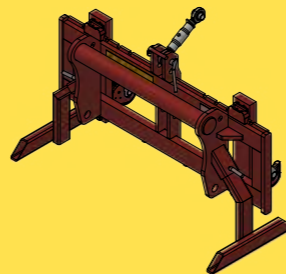

Adaptor Maniscopic - Three point hitch Cat. 2

**Machineside**  
Maniscopic  
**Equipment side**  
Three point hitch Cat. 2 Walterscheid



Are you looking for a specific adapter? Please contact us for the possibilities.

+31 (0)518 411318

[info@wifo.nl](mailto:info@wifo.nl)

## ATTACHMENTS



## ATTACHMENTS

ACCORD	€ 225,-	JCB Quick-Fit	€ 450,-
AHLMANN	€ 425,-	JLG	€ 450,-
ALÖ QUICKE (T-3 model)	€ 350,-	JOHN DEERE COMPACT (frontloader)	€ 300,-
ATLAS	€ 425,-	JOHN DEERE (telehandler)	€ 450,-
AVANT	€ 300,-	KRAMER	€ 425,-
BOBCAT (plate)	€ 400,-	LIEBHERR	€ 425,-
BOBCAT (telehandler)	€ 500,-	MACKS/OEHLER (plate)	€ 375,-
CATERPILLAR (plate)	€ 400,-	MAILLEUX	€ 325,-
CATERPILLAR (telehandler)	€ 450,-	MANITOU maniscopic	€ 500,-
CLAAS Kramer/Scorpion	€ 450,-	MATBRO	€ 450,-
CLAAS Ranger	€ 300,-	MERLO	€ 425,-
DEUTZ-FAHR	€ 450,-	MUSTANG	€ 450,-
DIECI	€ 450,-	NEW HOLLAND	€ 425,-
Three point hitch cat. 2 (machine side)	€ 225,-	O&K	€ 525,-
Three point hitch cat. 3 (machine side)	€ 275,-	PALAZZANI	€ 450,-
Three point hitch cat. 2 Walterscheid (equipment side)	€ 1.025,-	PAUS	€ 450,-
Three point hitch cat. 3 Walterscheid (equipment side)	€ 1.100,-	SCHÄEFF	€ 425,-
Euro (frontloader)	€ 225,-	SCHÄFFER	€ 525,-
Euro snelwissel (frontloader, equipment side)	€ 350,-	TEREX	€ 425,-
EUROTRAC	€ 375,-	THALER	€ 450,-
FAUCHEUX	€ 375,-	TRIMA	€ 350,-
FEM2 attachment	€ 225,-	VENIERI	€ 525,-
FEM3 attachment	€ 250,-	VERACHTERT SW-2003	€ 1.000,-
FEM 2 rapid coupling	€ 375,-	VERACHTERT CW-10 (hamerstoel)	€ 275,-
FEM 3 rapid coupling	€ 425,-	VERACHTERT CW-30 (hamerstoel)	€ 500,-
FUCHS (plaat)	€ 400,-	VOLVO L50-L120	€ 450,-
GENIE/TEREX	€ 375,-	VOLVO L150-L180	€ 750,-
GIANNI FERRARI (turboloader)	€ 300,-	WEIDEMANN	€ 400,-
GIANT	€ 375,-	WERKLUST	€ 550,-
JCB	€ 425,-	ZETTELMEYER	€ 450,-
JCB Changezee	€ 425,-		

# MEASUREMENT OVERVIEW OF ATTACHMENTS

## Fork carrier dimensions

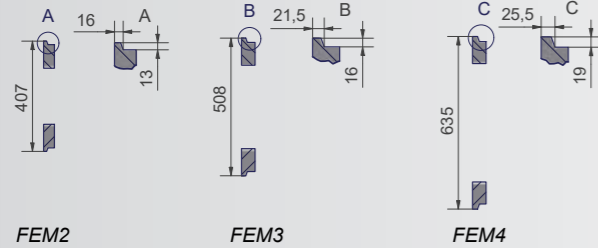

## 3-point hitch connection

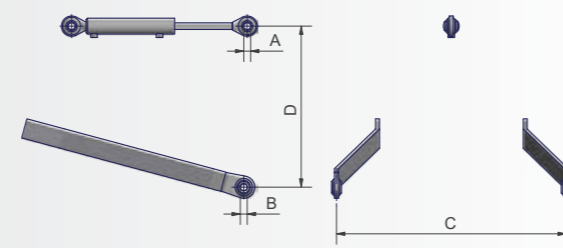

## Euro connection (for front loaders)

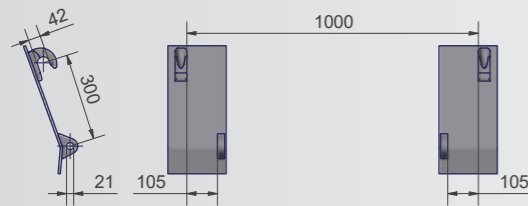

	A	B	C	D
Category 1	19 mm	22 mm	718 mm	460 mm
Category 2	26 mm	29 mm	870 mm	610 mm
Category 3	32 mm	37 mm	1010 mm	685 mm





MEER INFO?  
Scan the QR code

[WWW.WIFO.NL/EN](http://WWW.WIFO.NL/EN)  
For more information and specifications  
of our products

**SIMPLY!  
STRONG!**



 Hegebeintumerdyk 37 | 9172 GP | Ferwert | The Netherlands

 +31 (0)518 411318

 info@wifo.nl

 @wifoanema

 @wifoanema